



PMD33/34 Differential Pressure Transmitter



Application

- Silicon chips on Differential Pressure Module of MEMS integration technology
- Off set function by bottom / UI software
- Low-pressure monitoring, high pressure bearable
- Option RS-485 communication interface, Modbus RTU protocol
- DIP switch output and range
- Physical switch : mbar / Pa / hPa / kPa / mmH2O / mmWS / inH2O / mmHg
- Square root function
- Application Field — monitor differential pressure of Cleanroom / hospital / air duct / filter environment and monitor air flow

Specification

Input		Electrical	
Input type	Piezoelectric Differential Pressure Module	Power supply	8 ... 35 VDC / 12 ... 30 VAC
Measuring range	± 50 ~ ± 7500 pa	Current consumption	DC 8V : ≤ 130 mA(display) / ≤ 115 mA(non-display) DC 24V : ≤ 45 mA(display) / ≤ 40 mA(non-display) AC 12V : ≤ 150 mA(display) / ≤ 130 mA(non-display) AC 24V : ≤ 95 mA(display) / ≤ 90 mA(non-display)
Output		Overvoltage protection	≤ 40VDC
Output	0-20mA / 4-20mA / 0-1V / 0-5V / 1-5V / 2-10V / 0-10V	Electrical connection	M12 connector / M16 terminal
Signal connection	3-wire	Installation	
ModBus	RS-485	Installation	wall / duct
Accuracy (at 25°C)	± 2.0 % of F.S.	Protection	
Load resistance (current output)	4~20mA < 500Ω / 0~10V ≥ 10KΩ	Protect degree	IP 65
Response time (t 63)	≤ 2 ms	Electric protection	ⓄPolarity protection Ⓞover-voltage Ⓞshort circuit
Display Type	LCD Module with back light, double line character	Proof Pressure	± 50 ~ ± 250 pa : 0.25 bar ; ± 300 ~ ± 7500 pa : 0.5 bar
Display Range	upon request, 2 decimal place (as unit is Pa : 1 decimal place)	Burst Pressure	± 50 ~ ± 250 pa : 0.25 bar ; ± 300 ~ ± 7500 pa : 0.5 bar
Height of character	5.56 mm	Certification	
Environment		Certification	CE
Media measured	air	Material	
Environment Temperature	0...+50 °C	Case	PC fire-proof class (PC-110) (UL94V-2) display : 152g ; non-display : 127g
Environment Humidity	0~95 % (non-cond.)	Temperature Influence	
Storage temperature	-20...+60 °C	Temperature drift	± 1.75 % (5°C ... 55°C)

Ordering Guide

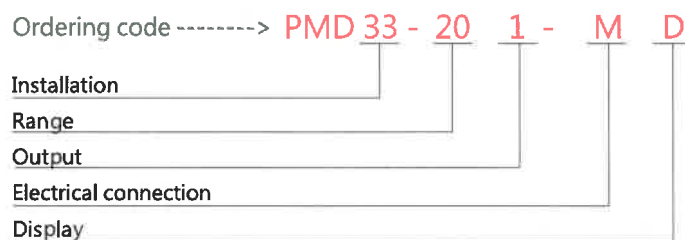

【 Ordering item 】

Installation	Code	Range	Code	Output	Code	Electrical Connection	Code	Option	Code
Indoor	33	± 50 / 100 / 250 pa	10	4~20mA	1	Plastic Cable Gland	N	Display	D
Duct	34	± 300 / 500 / 1000 pa	20	0~20mA	2	M12x1 metal connector	M	RS-485	1
		± 1000 / 1600 / 2500 pa	30	2~10V	4				
		± 2500 / 5000 / 7500 pa	40	1~5V	5				
				0~10V	6				
				0~5V	7				
				0~1V	8				

Pressure unit conversion table

Unit	Pa	mbar	hPa	kPa	mmWS	inH2O	mmHg
Range	± 50/100/250	0.5/1/2.5	0.5/1/2.5	0.05/0.1/0.25	5/10/25	0.2/0.4/1	0.375/0.75/1.875
	± 300/500/1000	3/5/10	3/5/10	0.3/0.5/1	30/50/100	1.2/2/4	2.25/3.75/7.5
	± 1000/1600/2500	10/16/25	10/16/25	1/1.6/2.5	100/160/250	4/6.4/10	7.5/12/18.75
	± 2500/5000/7500	25/50/75	25/50/75	2.5/5/7.5	250/500/750	10/20/30	18.75/37.5/93.75

Diagram

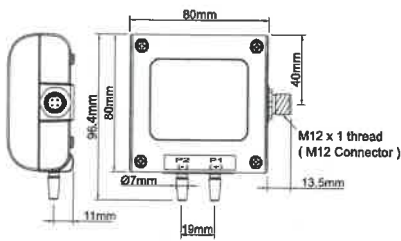

Indoor – M type

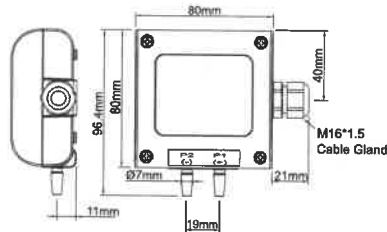

Indoor – N type

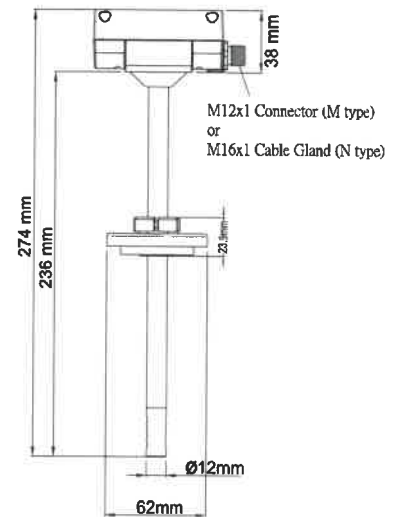

Duct

Connection

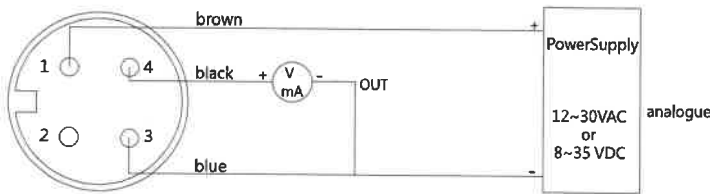

4P M12 Connector + Analogue

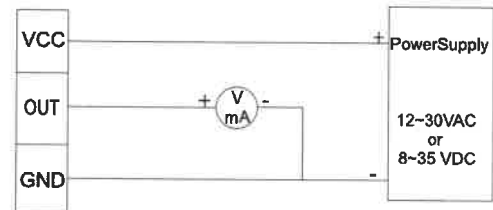

3P Terminal, Analogue

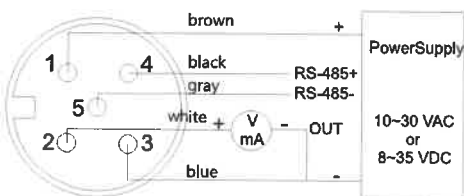

5P M12 Connector + RS-485

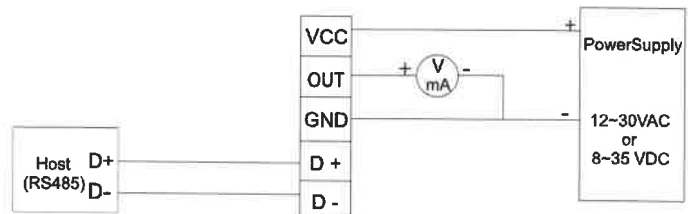

5P Terminal, Analogue + RS-485

DIP Switch

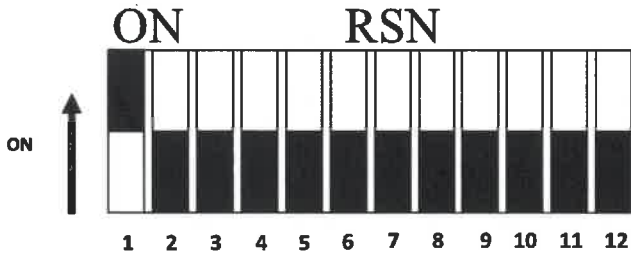

【 Function 】

- 1. DIP Switch Active / Deactivate
- 2. The Type for Analog Output
- 3 & 4. Switch Measuring range
- 5 & 6 & 7. Switch physical quantity unit
- 8. Zero switch
- 9. Linear / square root output switching
- 10. Filtering On / Off
- 11 & 12 . RS-485 Station no. switch

◎ 1. DIP Switch Active / Deactivate : Set the DIP switch as On/ Off

STATUS	OPEN	CLOSE
DIP Switch 1		

◎ 2. The Type for Analog Output

STATUS	0-10V	4-20mA
DIP Switch 2		

◎ 3 & 4. Switch Measuring range : upon ordering code (unit : Pa)

DIP Switch 3	DIP Switch 4	Range (10)	Range (20)	Range (30)	Range (40)
		50	300	1000	2500
		100	500	1600	5000
		250	1000	2500	7500
		upon request			

◎ 5 & 6 & 7. Switch physical quantity unit

DIP Switch 5	DIP Switch 6	DIP Switch 7	UNIT
			mbar
			Pa
			hPa
			kPa
			mmH2O
			mmWS
			inH2O
			mmHg

(Other unit : please reference pressure unit conversion table)

◎ 8. Zero switch

STATUS	0-100 %	-100~100%
DIP Switch 8		

◎ 9. Linear / square root output switching

STATUS	√	LINEAR
DIP Switch 9		

◎ 10. Filtering On / Off

STATUS	OPEN	CLOSE
DIP Switch 10		

◎ 11 & 12. RS-485 Station no. switch ID 1-4

DIP Switch 11	DIP Switch 12	STATION
		1
		2
		3
		4